



# V1161

## Dual-Port Programmable 100G Ethernet XMC ACAP Card

### Benefits

- Programmable interface solution that leverages off-the-shelf world class network performance with customizable application processor
- Heterogeneous computing card combining hard ARM processor cores, large FPGA fabric, and high bandwidth network interface controller
- Designed specifically for sensor interface and data processing, multi-level secure networking, and interface protocol bridging applications
- Adding to any single board computer provides a high bandwidth interface, configurable ACAP (FPGA) resources, and rugged optics
- Embedded focus with VITA 20 and VITA 47 compliance
- Versatile design supports electrical or optical interfaces, optical options for both backplane or front-panel VPX support
- Modular optics for flexibility in supporting 1-25Gbs per lane
- Options for 3U VPX, 6U VPX, and PXIe form factor via carrier cards

### Features

- Up to eight (8) 1G to 25G optical ports via MPO front panel I/O or VITA 66 optical backplane I/O. Electrical I/O via Pn6 also available
- Xilinx® Versal® ACAP (FPGA)
- NVIDIA® Mellanox® ConnectX®-5 Network Interface Device
- Hardware offloads for UDP, TCP, RoCE v2, DPDK, GPUDirect, NVMeoF, +more
- Supports PCIe Gen4 x16, Gen4 x8, Gen3 x16, Gen3 x8
- On board embedded PCIe Switch device
- Advanced APIs that support multi-core and multi-processor architectures
- Wide range of operating system software support

### Overview

The V1161 is a next generation high performance embedded computing XMC featuring the Xilinx® Versal™ Adaptive Compute Acceleration Platform (ACAP), the NVIDIA® Mellanox® ConnectX®-5 (MC-X5) network interface device, and rugged optical and electrical IO options. The V1161 is specifically targeted at applications requiring a combination of high speed interfaces, network offloads, and on-board payload processing resources. Use cases include sensor interface design with on-board data processing (or pre-processing), multi-level secure networking, and mixed protocol or protocol bridging applications. Radar, SIGINT, video, storage, medical imaging, and embedded communications systems all have the ability to benefit from the V1161 module.

The V1161 is a proven high-bandwidth and low-latency performance leader in 10/25/40/100Gbs Ethernet applications. The V1161 includes hardware offloads for UDP, TCP, RoCE v2, DPDK, GPUDirect, NVMeoF, and many other protocol stacks. The combination of the MC-X5 device and the ACAP device allows for system designers to leverage the off-the-shelf world class Ethernet performance while deploying unique data processing and security algorithms in the onboard ACAP device. This combination maximizes the effectiveness of the deployed algorithms while eliminating design efforts required to establish high bandwidth Ethernet, PCIe controllers, efficient DMA engines, or low overhead software drivers.

In addition to the Ethernet interfaces described, the FPGA fabric provided within the ACAP part is capable of hosting New Wave DV IP cores for Fibre Channel, ARINC-818, sFPDP, Aurora, and others. This makes the V1161 an ideal hardware platform for mixed interface protocol needs or protocol bridging applications.

The convenient XMC form factor and rugged design of the V1161 can turn a VPX-based single board computer into a single-slot sensor interface and heterogeneous computing solution. The V1161 mounted on a x86 based single board computer will provide 100G optical interfaces, FPGA fabric, ARM processor cores, and x86 processor cores all in a single slot solution. V1161 is also available from New Wave DV in a 3U VPX form-factor instead of XMC if desired.

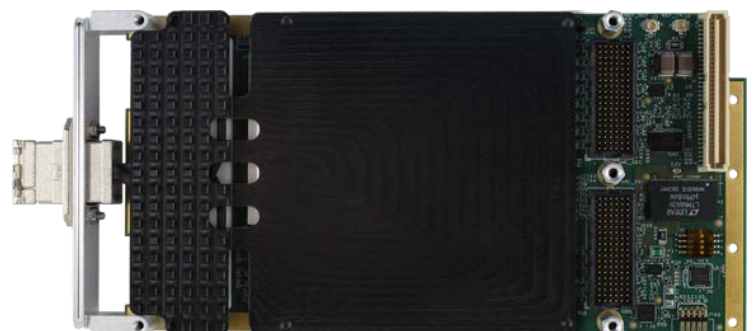

# V1161

## Dual-Port Programmable 100G Ethernet XMC ACAP Card

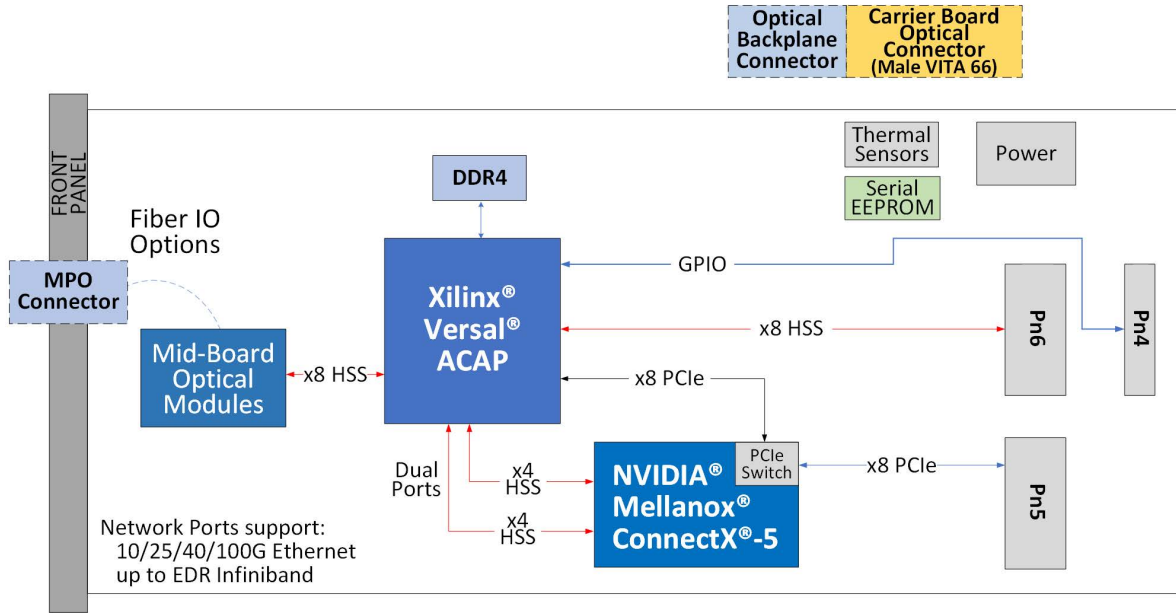

> V1161 XMC Block Diagram

## Connector Types

The V1160 offers five different I/O options:

- Electrical Backplane Connector via Pn6
- Optical Front Panel MPO Connector
- Optical Backplane MT Connector for VITA 66.1
- Optical Backplane MT Connector for VITA 66.4
- Custom Optical Cabling/Connector Options

### Backplane Slot Profile

When hosted on a New Wave VPX carrier, the V1160 provides a VITA 46.9 P1w9-X12d+“X4d” compliant interface

- “X4d” includes 4 pairs beyond the standard on P1w15 A/B, D/E and P1w16 B/C, E/F

1. Front Panel MPO I/O

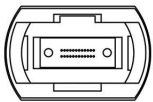

2. VITA 66.4 Backplane MT I/O

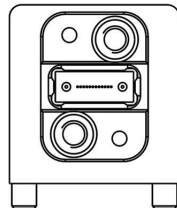

3. VITA 66.1 Backplane MT I/O

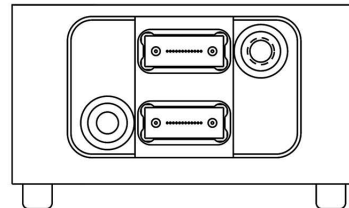

**KEY**

- New Wave-Provided Hardware
- Customer-Provided Hardware

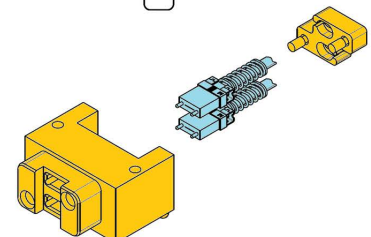
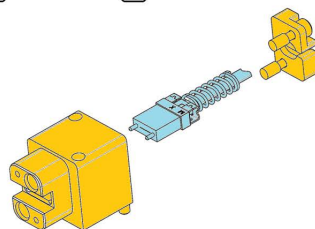

# V1161

## Dual-Port Programmable 100G Ethernet XMC ACAP Card

### Multi-Processor Multi-Core Support

The V1161 is uniquely suited for system architectures involving multiple processing cards on a common switched data plane. Specifically, the V1161 supports shared access from multiple host processors, enabling it to function as a cost-effective, high-performance gateway. This feature enables a single high-speed pipe to carry multiple virtual channels in systems that need to spread or load-balance sensor data across processor arrays.

### Complete Product Support Program

New Wave DV prides itself on its excellent customer support, a fact that is echoed by our customers. New Wave DV provides industry standard warranty on its products, but it is the human factor that makes our support so valuable to our customers. Our team takes the time and effort to ensure that the customer experience with our products is a positive one.

### Our Commitment

New Wave DV is committed to providing the latest innovations in technology, architectures, and techniques to keep our customers one step ahead of the rest. Our products, complete with the Development Framework, are intended to offer our customers an entirely unique out-of-the-box experience.

### Alternate Form Factors

The V1161 is designed for use in a variety of mission-critical applications. Whether you need its capabilities in XMC or other form factors such as VPX, PCIe, PXIe, or others, we're happy to help accommodate your needs and provide you with the solution best suited for your success.



PXIe



VPX



PCIe

### Technical Specifications

#### NETWORK INTERFACE

Up to eight (8) 1G to 25G optical ports (front & backplane options)

- 850nm multi-mode optics

Up to eight (8) 1G to 25G electrical ports to Pn6 (high-speed mezzanine connector)

Dual 10/25/40/100Gbps Ethernet port to MC-X5

#### ETHERNET PROTOCOLS

TCP, UDP, ARP, ICMP, RoCE v2, Multicast, Broadcast, + more

Visit NVIDIA® Mellanox® Datasheet<sup>1</sup>

#### ADDITIONAL PROTOCOLS

Fibre Channel, sFPDP, ARINC 818, Aurora

#### ACAP (FPGA) DEVICE

Xilinx Versal VM1502, VM1802

Visit Xilinx® Versal™ Datasheet<sup>3</sup>

#### ETHERNET DEVICE

NVIDIA® Mellanox® ConnectX®-5 EN IC

Visit NVIDIA® Mellanox® Datasheet<sup>1</sup>

#### HOST INTERFACE

PCI Express Gen4/Gen3 x8 (Pn5 to MC-X5)

PCI Express Gen4/Gen3 x8 (Pn6 to ACAP)

#### THERMAL SENSORS

2 digital temperature sensors

#### COMPLIANCE

VITA 20, 42.3, 47, 61.0, 88

NVIDIA® Mellanox® ConnectX®-5 EN IC

Visit NVIDIA® Mellanox® Datasheet<sup>1</sup>

#### SOFTWARE SUPPORT

Software drivers available from NVIDIA® Mellanox®<sup>2</sup>

NWDV Maintained x86 OS's: <https://newwavedv.com/wordpress/wp-content/uploads/2021/08/V1161-software-info-2021.pdf>

#### PHYSICAL CHARACTERISTICS

Dimensions: 74 mm (width) x 143.75 mm (length)

Weight: 0.276 lbs

#### POWER CHARACTERISTICS

Power Draw: Maximum 40W

Power Supply: 5V to 12V

#### TEMPERATURE

Operating: -40° C to 55° C at 250 LFM (air-cooled)

Operating: -40° C to 85° C (conduction-cooled)

Storage: -55° C to 105° C

<sup>1</sup>NVIDIA® Mellanox® ConnectX®-5 EN IC Datasheet: <https://www.mellanox.com/sites/default/files/doc-2020/pb-connectx-5-en-ic.pdf>

<sup>2</sup>NVIDIA® Mellanox® Ethernet Software Support/Datasheet: <https://www.mellanox.com/products/adapter-ethernet-sw>

<sup>3</sup>Xilinx Versal ACAP Datasheet: [https://www.xilinx.com/content/dam/xilinx/support/documentation/data\\_sheets/ds950-versal-overview.pdf](https://www.xilinx.com/content/dam/xilinx/support/documentation/data_sheets/ds950-versal-overview.pdf)

#### FOR MORE INFORMATION

www.newwavedv.com  
info@newwavedv.com  
Phone +1 952-224-9201

New Wave DV  
10260 Viking Drive, Ste 250  
Eden Prairie, MN 55344 USA

